



中国认可
国际互认
检测
TESTING
CNAS L6165

Test Report issued under the responsibility of:

TCT 通测检测
TESTING CENTRE TECHNOLOGY

<p>TEST REPORT IEC 62133-2</p> <p>Secondary cells and batteries containing alkaline or other non-acid electrolytes – Safety requirements for portable sealed secondary cells, and for batteries made from them, for use in portable applications – Part 2: Lithium systems</p>	
Report Number.....	TCT250804B038
Date of issue.....	2025-08-14
Total number of pages	30 pages
Name of Testing Laboratory preparing the Report	Shenzhen TCT Testing Technology Co., Ltd.
Applicant's name	Shenzhen Nova Technology Limited
Address.....	Zehua Building, Longhua Road 3698, Longhua District, Shenzhen, China 518106
Test specification:	
Standard	IEC 62133-2:2017, IEC 62133-2:2017/AMD1:2021
Test procedure	Type approved
Non-standard test method	N/A
TRF template used.....	IECEE OD-2020-F1:2021, Ed.1.4
Test Report Form No.	IEC62133_2C
Test Report Form(s) Originator	DEKRA Certification B.V.
Master TRF	Dated 2022-07-01
<p>Copyright © 2022 IEC System of Conformity Assessment Schemes for Electrotechnical Equipment and Components (IECEE System). All rights reserved.</p> <p>This publication may be reproduced in whole or in part for non-commercial purposes as long as the IECEE is acknowledged as copyright owner and source of the material. IECEE takes no responsibility for and will not assume liability for damages resulting from the reader's interpretation of the reproduced material due to its placement and context.</p> <p>If this Test Report Form is used by non-IECEE members, the IECEE/IEC logo and the reference to the CB Scheme procedure shall be removed.</p> <p>This report is not valid as a CB Test Report unless signed by an approved IECEE Testing Laboratory and appended to a CB Test Certificate issued by an NCB in accordance with IECEE 02.</p>	
General disclaimer:	
<p>The test results presented in this report relate only to the object tested.</p> <p>This report shall not be reproduced, except in full, without the written approval of the Issuing CB Testing Laboratory. The authenticity of this Test Report and its contents can be verified by contacting the NCB, responsible for this Test Report.</p>	

Test item description :	Li-ion Polymer Battery	
Trade Mark(s)	N/A	
Manufacturer	Shenzhen Nova Technology Limited Zehua Building, Longhua Road 3698, Longhua District, Shenzhen, China 518106	
Model/Type reference	802050P	
Ratings	3.7V, 850mAh, 3.145Wh	
Responsible Testing Laboratory (as applicable), testing procedure and testing location(s):		
<input checked="" type="checkbox"/>	CB Testing Laboratory:	Shenzhen TCT Testing Technology Co., Ltd.
Testing location/ address :	2101&2201, Zhenchang Factory, Renshan Industrial Zone, Fuhai Street, Bao'an District, Shenzhen, China	
Tested by (name, function, signature)	May Hou (Test Engineer)	<i>May Hou</i>
Inspected by (name, function, signature) :	Aiden Liu (Project Engineer)	<i>Aiden. Liu</i>
Approved by (name, function, signature) :	Evan Chen (Reviewer)	<i>Evan Chen</i>
<input type="checkbox"/>	Testing procedure: CTF Stage 1:	
Testing location/ address :		
Tested by (name, function, signature)		
Approved by (name, function, signature) :		
<input type="checkbox"/>	Testing procedure: CTF Stage 2:	
Testing location/ address :		
Tested by (name + signature)		
Witnessed by (name, function, signature) .:		
Approved by (name, function, signature) :		
<input type="checkbox"/>	Testing procedure: CTF Stage 3:	
<input type="checkbox"/>	Testing procedure: CTF Stage 4:	
Testing location/ address :		
Tested by (name, function, signature)		
Witnessed by (name, function, signature) .:		
Approved by (name, function, signature) :		
Supervised by (name, function, signature) :		

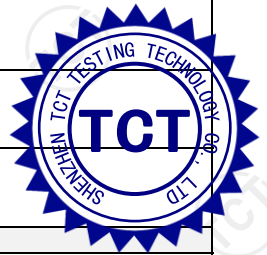

<p>List of Attachments (including a total number of pages in each attachment): Attachment 1: Photo documentation (4 pages).</p>	
<p>Summary of testing:</p>	
<p>Tests performed (name of test and test clause): cl.5.6.2 Design recommendation; cl.7.1 Charging procedure for test purposes (for Cells and Batteries); cl.7.2.1 Continuous charging at constant voltage (Cells); cl.7.3.1 External short circuit (Cells); cl.7.3.2 External short circuit (Batteries); cl.7.3.3 Free fall (Cells and Batteries); cl.7.3.4 Thermal abuse (Cells); cl.7.3.5 Crush (Cells); cl.7.3.6 Over-charging of battery; cl.7.3.7 Forced discharge (Cells); cl.7.3.8 Mechanical tests (Batteries); cl.7.3.9 Design evaluation – Forced internal short circuit (Cells);</p> <p>The electrolyte type of this cell doesn't belong to polymer, and the addition test cl.7.3.9 was carried out to evaluate the cell.</p> <p>Tests are made with the number of cells and batteries specified in IEC 62133-2:2017, IEC 62133-2:2017/AMD1:2021 Table 1.</p>	<p>Testing location: Shenzhen TCT Testing Technology Co., Ltd. 2101&2201, Zhenchang Factory, Renshan Industrial Zone, Fuhai Street, Bao'an District, Shenzhen, China</p>
<p>Summary of compliance with National Differences (List of countries addressed): N/A</p> <p><input checked="" type="checkbox"/> The product fulfils the requirements of <u>EN 62133-2:2017, EN 62133-2:2017/A1:2021</u></p>	

Test item particulars:	
Classification of installation and use:	To be defined in final product
Supply Connection	DC Connector
Recommend charging method declared by the manufacturer	Charging the battery with 425mA constant current and 4.2V constant voltage until the current reduces to 8.5mA at ambient 20°C±5°C.
Discharge current (0,2 It A)	170mA
Specified final voltage:	3.0V
Upper limit charging voltage per cell:	4.2V
Maximum charging current	850mA
Charging temperature upper limit	45°C
Charging temperature lower limit:	0°C
Polymer cell electrolyte type:	<input type="checkbox"/> gel polymer <input type="checkbox"/> solid polymer <input checked="" type="checkbox"/> N/A
Possible test case verdicts:	
- test case does not apply to the test object.....:	N/A
- test object does meet the requirement.....:	P (Pass)
- test object does not meet the requirement.....:	F (Fail)
Testing:	
Date of receipt of test item	2025-08-01
Date (s) of performance of tests	2025-08-01 to 2025-08-14
General remarks:	
"(See Enclosure #)" refers to additional information appended to the report. "(See appended table)" refers to a table appended to the report.	
Throughout this report a <input type="checkbox"/> comma / <input checked="" type="checkbox"/> point is used as the decimal separator.	
Manufacturer's Declaration per sub-clause 4.2.5 of IEC62133-2:	
The application for obtaining a CB Test Certificate includes more than one factory location and a declaration from the Manufacturer stating that the sample(s) submitted for evaluation is (are) representative of the products from each factory has been provided	<input type="checkbox"/> Yes <input checked="" type="checkbox"/> Not applicable
When differences exist; they shall be identified in the General product information section.	
Name and address of factory (ies)	
: Same as manufacturer	

General product information and other remarks:

This battery is constructed with a single lithium-ion cell, and has overcharge, over-discharge, over current and short-circuits proof circuit.

The main features of the battery are shown as below (clause 7.1.1):

Model (Battery)	Rated capacity	Nominal voltage	Nominal Charge Current	Nominal Discharge Current	Maximum Charge Current	Maximum Discharge Current	Maximum Charge Voltage	Final Voltage
802050P	850mAh	3.7V	425mA	170mA	850mA	1275mA	4.2V	3.0V

The main features of the cell in the battery are shown as below (clause 7.1.1):

Model (Cell)	Rated capacity	Nominal voltage	Nominal Charge Current	Nominal Discharge Current	Maximum Charge Current	Maximum Discharge Current	Maximum Charge Voltage	Final Voltage
802050P	850mAh	3.7V	425mA	170mA	850mA	1275mA	4.2V	3.0V

The main features of the cell in the battery are shown as below (clause 7.1.2):

Model (Cell)	Upper limit charge voltage	Taper-off current	Lower charge temperature	Upper charge temperature
802050P	4.2V	42.5mA	0°C	45°C

Construction:

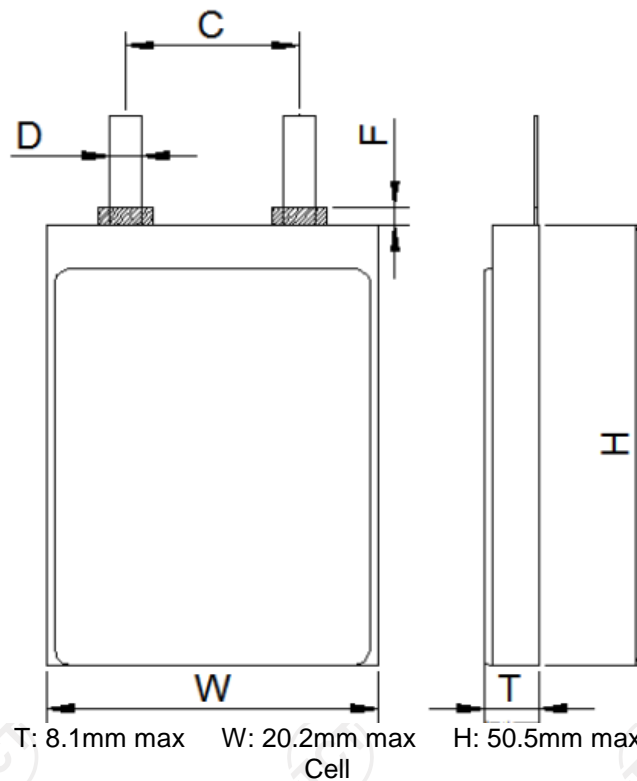

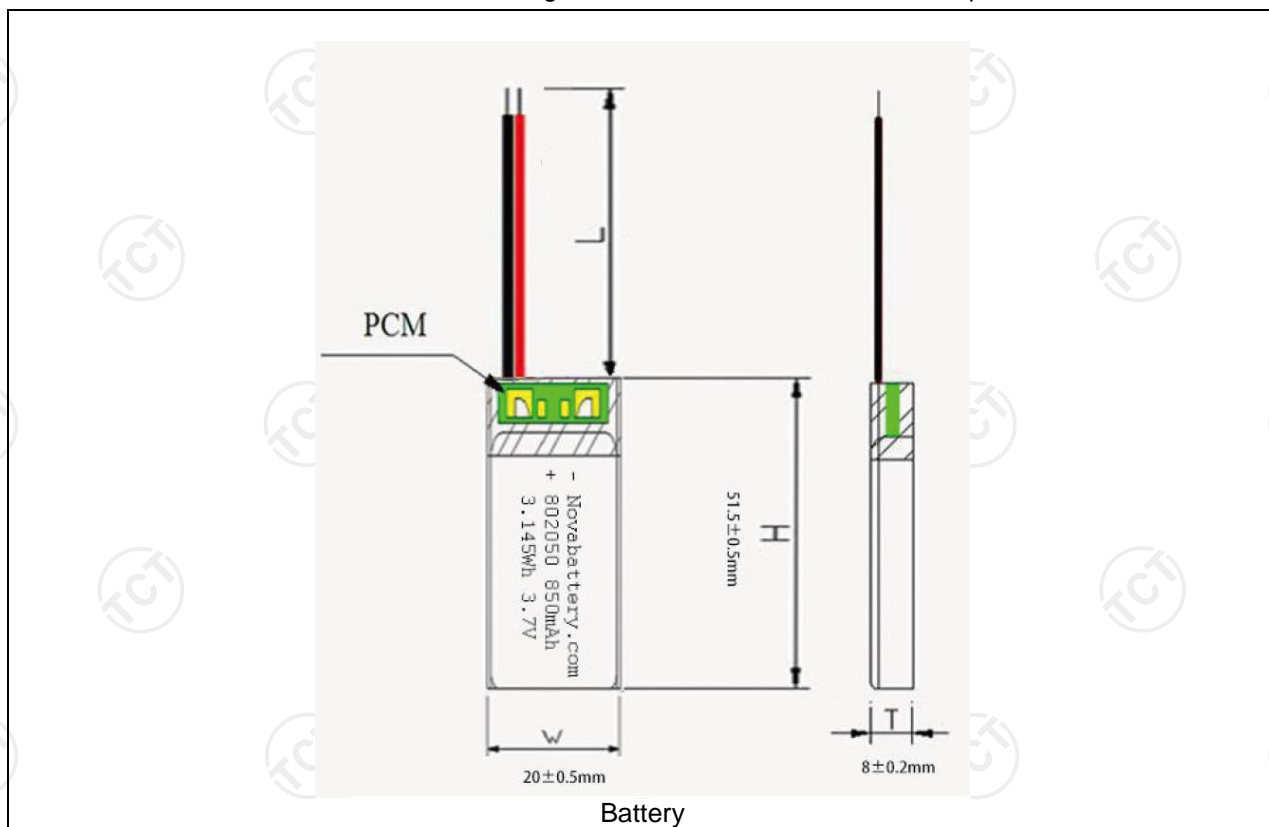

Circuit diagram:

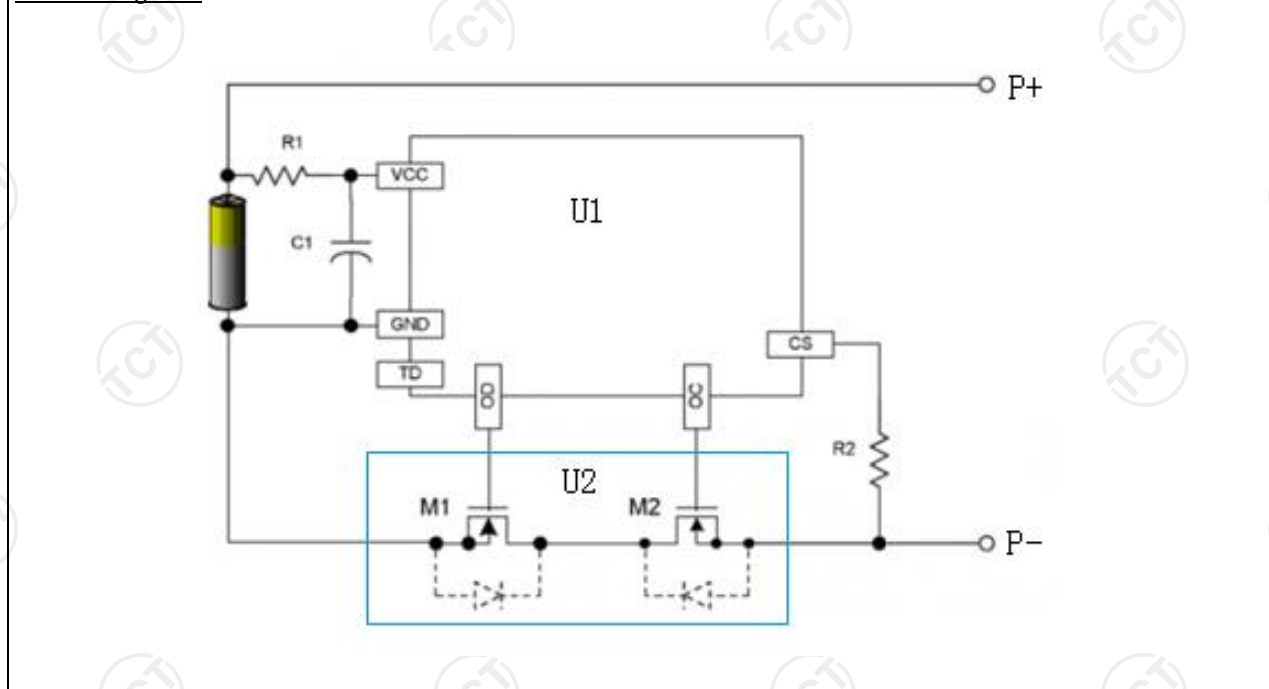

IEC 62133-2			
Clause	Requirement + Test	Result - Remark	Verdict
4	PARAMETER MEASUREMENT TOLERANCES		P
	Parameter measurement tolerances		P
5	GENERAL SAFETY CONSIDERATIONS		P
5.1	General		P
	Cells and batteries so designed and constructed that they are safe under conditions of both intended use and reasonably foreseeable misuse		P
5.2	Insulation and wiring		P
	The insulation resistance between the positive terminal and externally exposed metal surfaces of the battery (excluding electrical contact surfaces) is not less than 5 MΩ	No metal surface exists.	N/A
	Insulation resistance (MΩ) :		—
	Internal wiring and insulation are sufficient to withstand maximum anticipated current, voltage and temperature requirements		P
	Orientation of wiring maintains adequate clearances and creepage distances between conductors		P
	Mechanical integrity of internal connections accommodates reasonably foreseeable misuse		P
5.3	Venting		P
	Battery cases and cells incorporate a pressure relief mechanism or are constructed so that they relieve excessive internal pressure at a value and rate that will preclude rupture, explosion and self-ignition	Venting mechanism exists on the narrow side of pouch cell.	P
	Encapsulation used to support cells within an outer casing does not cause the battery to overheat during normal operation nor inhibit pressure relief		N/A
5.4	Temperature, voltage and current management		P
	Batteries are designed such that abnormal temperature rise conditions are prevented	Overcharge, over discharge, over current and short-circuit proof circuit used in this battery. See tests of clause 7.	P
	Batteries are designed to be within temperature, voltage and current limits specified by the cell manufacturer	See above.	P
	Batteries are provided with specifications and charging instructions for equipment manufacturers so that specified chargers are designed to maintain charging within the temperature, voltage and current limits specified	The charging limits specified in the manufacturer's specification.	P
5.5	Terminal contacts		P

IEC 62133-2			
Clause	Requirement + Test	Result - Remark	Verdict
	The size and shape of the terminal contacts ensure that they can carry the maximum anticipated current	DC Connector contacts complied with the requirements.	P
	External terminal contact surfaces are formed from conductive materials with good mechanical strength and corrosion resistance		P
	Terminal contacts are arranged to minimize the risk of short circuits		P
5.6	Assembly of cells into batteries		P
5.6.1	General		P
	Each battery has an independent control and protection for current, voltage, temperature and any other parameter required for safety and to maintain the cells within their operating region	Protective circuit equipped on battery.	P
	This protection may be provided external to the battery such as within the charger or the end devices		N/A
	If protection is external to the battery, the manufacturer of the battery provide this safety relevant information to the external device manufacturer for implementation		N/A
	If there is more than one battery housed in a single battery case, each battery has protective circuitry that can maintain the cells within their operating regions		N/A
	Manufacturers of cells specify current, voltage and temperature limits so that the battery manufacturer/designer may ensure proper design and assembly	Current, voltage and temperature limits specified by cell manufacturer.	P
	Batteries that are designed for the selective discharge of a portion of their series connected cells incorporate circuitry to prevent operation of cells outside the limits specified by the cell manufacturer		N/A
	Protective circuit components are added as appropriate and consideration given to the end-device application		P
	The manufacturer of the battery provide a safety analysis of the battery safety circuitry with a test report including a fault analysis of the protection circuit under both charging and discharging conditions confirming the compliance	Safety analysis report provided by manufacturer.	P
5.6.2	Design recommendation		P
	For the battery consisting of a single cell or a single cellblock, it is recommended that the charging voltage of the cell does not exceed the upper limit of the charging voltage specified in Table 2	Single cell battery, Max. Charging voltage of cell: 4.2V.	P

IEC 62133-2			
Clause	Requirement + Test	Result - Remark	Verdict
	For the battery consisting of series-connected plural single cells or series-connected plural cellblocks, it is recommended that the voltages of any one of the single cells or single cellblocks does not exceed the upper limit of the charging voltage, specified in Table 2, by monitoring the voltage of every single cell or the single cellblocks		N/A
	For the battery consisting of series-connected plural single cells or series-connected plural cellblocks, it is recommended that charging is stopped when the upper limit of the charging voltage is exceeded for any one of the single cells or single cellblocks by measuring the voltage of every single cell or the single cellblocks		N/A
	For batteries consisting of series-connected cells or cell blocks, nominal charge voltage are not counted as an overcharge protection		N/A
	For batteries consisting of series-connected cells or cell blocks, cells have closely matched capacities, be of the same design, be of the same chemistry and be from the same manufacturer		N/A
	It is recommended that the cells and cell blocks are not discharged beyond the cell manufacturer's specified final voltage	Final voltage of cell assembled in the battery: 3.0V, not less than final voltage specified by cell manufacturer.	P
	For batteries consisting of series-connected cells or cell blocks, cell balancing circuitry are incorporated into the battery management system		N/A
5.6.3	Mechanical protection for cells and components of batteries		P
	Mechanical protection for cells, cell connections and control circuits within the battery are provided to prevent damage as a result of intended use and reasonably foreseeable misuse	Mechanical protection for cell connections and control circuits provided.	P
	The mechanical protection can be provided by the battery case or it can be provided by the end product enclosure for those batteries intended for building into an end product	Build-in batteries, mechanical protection for cells should be provided by end product.	N/A
	The battery case and compartments housing cells are designed to accommodate cell dimensional tolerances during charging and discharging as recommended by the cell manufacturer	To be evaluated in final system.	N/A
	For batteries intended for building into a portable end product, testing with the battery installed within the end product is considered when conducting mechanical tests		N/A
5.7	Quality plan		P

IEC 62133-2			
Clause	Requirement + Test	Result - Remark	Verdict
	The manufacturer prepares and implements a quality plan that defines procedures for the inspection of materials, components, cells and batteries and which covers the whole process of producing each type of cell or battery	Complied. Quality plan provided.	P
5.8	Battery safety components	See TABLE: Critical components information	N/A

6	TYPE TEST AND SAMPLE SIZE		P
	Tests are made with the number of cells or batteries specified in Table 1 using cells or batteries that are not more than six months old		P
	The internal resistance of coin cells are measured in accordance with Annex D. Coin cells with internal resistance less than or equal to 3 Ω are tested in accordance with Table 1	Not coin cells	N/A
	Unless otherwise specified, tests are carried out in an ambient temperature of 20 °C ± 5 °C		P
	The safety analysis of 5.6.1 identify those components of the protection circuit that are critical for short-circuit, overcharge and over discharge protection		P
	When conducting the short-circuit test, consideration is given to the simulation of any single fault condition that is likely to occur in the protecting circuit that would affect the short-circuit test	See clause 7.3.2.	P

7	SPECIFIC REQUIREMENTS AND TESTS		P
7.1	Charging procedure for test purposes		P
7.1.1	First procedure		P
	This charging procedure applies to subclauses other than those specified in 7.1.2		P
	Unless otherwise stated in this document, the charging procedure for test purposes is carried out in an ambient temperature of 20 °C ± 5 °C, using the method declared by the manufacturer	See page 5.	P
	Prior to charging, the battery has been discharged at 20 °C ± 5 °C at a constant current of 0,2 It A down to a specified final voltage	See page 5.	P
7.1.2	Second procedure		P
	This charging procedure applies only to 7.3.1, 7.3.4, 7.3.5, and 7.3.9		P

IEC 62133-2			
Clause	Requirement + Test	Result - Remark	Verdict
	After stabilization for 1 h to 4 h, at an ambient temperature of the highest test temperature and the lowest test temperature, respectively, as specified in Table 2, cells are charged by using the upper limit charging voltage and maximum charging current, until the charging current is reduced to 0,05 It A, using a constant current to constant voltage charging method	Charge temperature specified by manufacturer: 0-45°C. 0°C used for lower limit tests. 45°C used for upper limit tests.	P
7.2	Intended use		P
7.2.1	Continuous charging at constant voltage (cells)		P
	Fully charged cells are subjected for 7 days to a charge using the charging method for current and standard voltage specified by the cell manufacturer	Charging for 7days with 425mA.	P
	Results: no fire, no explosion, no leakage.....:	(See appended table 7.2.1)	P
7.2.2	Case stress at high ambient temperature (battery)		N/A
	Oven temperature (°C).....:		—
	Results: no physical distortion of the battery case resulting in exposure of internal protective components and cells		N/A
7.3	Reasonably foreseeable misuse		P
7.3.1	External short-circuit (cell)	Tested complied.	P
	The cells were tested until one of the following occurred:		P
	- 24 hours elapsed; or		N/A
	- The case temperature declined by 20 % of the maximum temperature rise		P
	Results: no fire, no explosion.....:	(See appended table 7.3.1)	P
7.3.2	External short-circuit (battery)	Tested complied.	P
	The batteries were tested until one of the following occurred:		P
	- 24 hours elapsed; or		N/A
	- The case temperature declined by 20 % of the maximum temperature rise		P
	In case of rapid decline in short circuit current, the battery pack remained on test for an additional one hour after the current reached a low end steady state condition		P
	A single fault in the discharge protection circuit is conducted on one to four (depending upon the protection circuit) of the five samples before conducting the short-circuit test	Single fault conducted on three samples.	P

IEC 62133-2			
Clause	Requirement + Test	Result - Remark	Verdict
	A single fault applies to protective component parts such as MOSFET (metal oxide semiconductor field-effect transistor), fuse, thermostat or positive temperature coefficient (PTC) thermistor	Single fault applies on MOSFET U2.	P
	Results: no fire, no explosion	(See appended table 7.3.2)	P
7.3.3	Free fall	Tested complied.	P
	Results: no fire, no explosion	No fire. No explosion	P
7.3.4	Thermal abuse (cells)	Tested complied.	P
	Oven temperature (°C)	130°C	—
	Results: no fire, no explosion	No fire. No explosion	P
7.3.5	Crush (cells)	Tested complied.	P
	The crushing force was released upon:		P
	- The maximum force of 13 kN ± 0,78 kN has been applied; or		P
	- An abrupt voltage drop of one-third of the original voltage has been obtained		N/A
	Results: no fire, no explosion	(See appended table 7.3.5)	P
7.3.6	Over-charging of battery	Tested complied.	P
	The supply voltage which is:		P
	- 1,4 times the upper limit charging voltage presented in Table A.1 (but not to exceed 6,0 V) for single cell/cell block batteries or	5.88V applied.	P
	- 1,2 times the upper limit charging voltage resented in Table A.1 per cell for series connected multi-cell batteries, and		N/A
	- Sufficient to maintain a current of 2,0 It A throughout the duration of the test or until the supply voltage is reached		P
	Test was continued until the temperature of the outer casing:		P
	- Reached steady state conditions (less than 10 °C change in 30-minute period); or		N/A
	- Returned to ambient		P
	Results: no fire, no explosion	(See appended table 7.3.6)	P
7.3.7	Forced discharge (cells)	Tested complied.	P
	Discharge a single cell to the lower limit discharge voltage specified by the cell manufacturer	Lower limit discharge voltage 3.0V	P
	The discharged cell is then subjected to a forced discharge at 1 It A to the negative value of the upper limit charging voltage		P

IEC 62133-2			
Clause	Requirement + Test	Result - Remark	Verdict
	- The discharge voltage reaches the negative value of upper limit charging voltage within the testing duration. The voltage is maintained at the negative value of the upper limit charging voltage by reducing the current for the remainder of the testing duration		N/A
	- The discharge voltage does not reach the negative value of upper limit charging voltage within the testing duration. The test is terminated at the end of the testing duration		P
	Results: no fire, no explosion..... :	(See appended table 7.3.7)	P
7.3.8	Mechanical tests (batteries)		P
7.3.8.1	Vibration	Tested complied.	P
	Results: no fire, no explosion, no rupture, no leakage or venting. :	(See appended table 7.3.8.1)	P
7.3.8.2	Mechanical shock	Tested complied.	P
	Results: no leakage, no venting, no rupture, no explosion and no fire :	(See appended table 7.3.8.2)	P
7.3.9	Design evaluation – Forced internal short-circuit (cells)	Tested complied.	P
	The cells complied with national requirement for :	France, Japan, Republic of Korea and Switzerland.	—
	The pressing was stopped upon:		P
	- A voltage drop of 50 mV has been detected; or		N/A
	- The pressing force of 800 N (cylindrical cells) or 400 N (prismatic cells) has been reached	400N for prismatic cell.	P
	Results: no fire..... :	(See appended table 7.3.9)	P
8	INFORMATION FOR SAFETY		P
8.1	General		P
	Manufacturers of secondary cells provides information about current, voltage and temperature limits of their products	Information for safety mentioned in manufacturer's specifications.	P
	Manufacturers of batteries provides information regarding how to minimize and mitigate hazards to equipment manufacturers or end-users	Information for safety mentioned in manufacturer's specifications.	P
	Systems analyses are performed by device manufacturers to ensure that a particular battery design prevents hazards from occurring during use of a product		N/A
	As appropriate, any information relating to hazard avoidance resulting from a system analysis is provided to the end user		N/A

IEC 62133-2			
Clause	Requirement + Test	Result - Remark	Verdict
	Do not allow children to replace batteries without adult supervision		N/A
8.2	Small cell and battery safety information	Small cells and batteries.	P
	The following warning language is to be provided with the information packaged with the small cells and batteries or equipment using them:	Information for safety mentioned in manufacturer's specifications and on equipment's package.	P
	- Keep small cells and batteries which are considered swallowable out of the reach of children		P
	- Swallowing may lead to burns, perforation of soft tissue, and death. Severe burns can occur within 2 h of ingestion		P
	- In case of ingestion of a cell or battery, seek medical assistance promptly		P

9	MARKING		P
9.1	Cell marking	The final product is battery	N/A
	Cells are marked as specified in IEC 61960, except coin cells		N/A
	Coin cells whose external surface area is too small to accommodate the markings on the cells show the designation and polarity		N/A
	By agreement between the cell manufacturer and the battery and/or end product manufacturer, component cells used in the manufacture of a battery need not be marked		N/A
9.2	Battery marking		P
	Batteries are marked as specified in IEC 61960, except for coin batteries	See marking plate.	P
	Coin batteries whose external surface area is too small to accommodate the markings on the batteries show the designation and polarity	Not coin batteries.	N/A
	Batteries are marked with an appropriate caution statement		P
	- Terminals have clear polarity marking on the external surface of the battery, or	The "- (Black)" and "+ (Red)" polarity explicitly marked on surface of the battery.	P
	- Not be marked with polarity markings if the design of the external connector prevents reverse polarity connections	DC Connector used.	P
9.3	Caution for ingestion of small cells and batteries		N/A

IEC 62133-2			
Clause	Requirement + Test	Result - Remark	Verdict
	Coin cells and batteries identified as small batteries include a caution statement regarding the hazards of ingestion in accordance with 8.2	Not coin cells. Not coin batteries.	N/A
	Small cells and batteries are intended for direct sale in consumer-replaceable applications, caution for ingestion is given on the immediate package	Not intended for direct sale.	N/A
9.4	Other information		P
	The following information are marked on or supplied with the battery:		P
	- Storage and disposal instructions	Information for storage and disposal instructions mentioned in manufacturer's specifications.	P
	- Recommended charging instructions	Information for recommended charging instructions mentioned in manufacturer's specifications.	P

10	PACKAGING AND TRANSPORT		N/A
	Packaging for coin cells are not be small enough to fit within the limits of the ingestion gauge of Figure 3	Not coin cells.	N/A

ANNEX A	CHARGING AND DISCHARGING RANGE OF SECONDARY LITHIUM ION CELLS FOR SAFE USE		P
A.1	General		P
A.2	Safety of lithium ion secondary battery	Complied.	P
A.3	Consideration on charging voltage	Complied.	P
A.3.1	General		P
A.3.2	Upper limit charging voltage	4.2V applied.	P
A.3.2.1	General		P
A.3.2.2	Explanation of safety viewpoint		P
A.3.2.3	Safety requirements, when different upper limit charging voltage is applied	4.2V applied.	P
A.4	Consideration of temperature and charging current		P
A.4.1	General		P
A.4.2	Recommended temperature range	See A.4.2.2.	P
A.4.2.1	General		P
A.4.2.2	Safety consideration when a different recommended temperature range is applied	Charging temperature range declared by client is: 0-45°C	P
A.4.3	High temperature range		N/A

IEC 62133-2			
Clause	Requirement + Test	Result - Remark	Verdict
A.4.3.1	General		N/A
A.4.3.2	Explanation of safety viewpoint		N/A
A.4.3.3	Safety considerations when specifying charging conditions in the high temperature range		N/A
A.4.3.4	Safety considerations when specifying a new upper limit in the high temperature range		N/A
A.4.4	Low temperature range		N/A
A.4.4.1	General		N/A
A.4.4.2	Explanation of safety viewpoint		N/A
A.4.4.3	Safety considerations, when specifying charging conditions in the low temperature range		N/A
A.4.4.4	Safety considerations when specifying a new lower limit in the low temperature range		N/A
A.4.5	Scope of the application of charging current		P
A.4.6	Consideration of discharge		P
A.4.6.1	General		P
A.4.6.2	Final discharge voltage and explanation of safety viewpoint	Cell specified final voltage 3.0V, not exceed 3.0V specified by cell manufacturer.	P
A.4.6.3	Discharge current and temperature range		P
A.4.6.4	Scope of application of the discharging current		P
A.5	Sample preparation		P
A.5.1	General		P
A.5.2	Insertion procedure for nickel particle to generate internal short		P
A.5.3	Disassembly of charged cell		P
A.5.4	Shape of nickel particle		P
A.5.5	Insertion of nickel particle in cylindrical cell		N/A
A.5.5.1	Insertion of nickel particle in winding core		N/A
A.5.5.2	Marking the position of the nickel particle on both ends of the winding core of the separator		N/A
A.5.6	Insertion of nickel particle in prismatic cell		P
A.6	Experimental procedure of the forced internal short-circuit test		P
A.6.1	Material and tools for preparation of nickel particle		P
A.6.2	Example of a nickel particle preparation procedure		P
A.6.3	Positioning (or placement) of a nickel particle		P
A.6.4	Damaged separator precaution		P

IEC 62133-2			
Clause	Requirement + Test	Result - Remark	Verdict
A.6.5	Caution for rewinding separator and electrode		P
A.6.6	Insulation film for preventing short-circuit		P
A.6.7	Caution when disassembling a cell		P
A.6.8	Protective equipment for safety		P
A.6.9	Caution in the case of fire during disassembling		P
A.6.10	Caution for the disassembling process and pressing the electrode core		P
A.6.11	Recommended specifications for the pressing device		P

ANNEX B	RECOMMENDATIONS TO EQUIPMENT MANUFACTURERS AND BATTERY ASSEMBLERS	N/A
----------------	--	-----

ANNEX C	RECOMMENDATIONS TO THE END-USERS	N/A
----------------	---	-----

ANNEX D	MEASUREMENT OF THE INTERNAL AC RESISTANCE FOR COIN CELLS	N/A
D.1	General	N/A
D.2	Method	N/A
	A sample size of three coin cells is required for this measurement	N/A
	Coin cells with an internal resistance greater than 3 Ω require no further testing	N/A
	Coin cells with an internal resistance less than or equal to 3 Ω are subjected to the testing according to Clause 6 and Table 1	N/A

ANNEX E	PACKAGING AND TRANSPORT	N/A
----------------	--------------------------------	-----

ANNEX F	COMPONENT STANDARDS REFERENCES	N/A
----------------	---------------------------------------	-----

IEC 62133-2					
Clause	Requirement + Test			Result - Remark	Verdict
7.2.1	TABLE: Continuous charging at constant voltage (cells)				P
Sample No.	Recommended charging voltage Vc (Vdc)	Recommended charging current I _{rec} (A)	OCV before test (Vdc)	Results	
TS250704018C01	4.20	0.425	4.19	A, B, C	
TS250704018C02	4.20	0.425	4.19	A, B, C	
TS250704018C03	4.20	0.425	4.18	A, B, C	
TS250704018C04	4.20	0.425	4.19	A, B, C	
TS250704018C05	4.20	0.425	4.18	A, B, C	
Supplementary information:					
A - No fire					
B - No explosion					
C - No leakage					

IEC 62133-2					
Clause	Requirement + Test			Result - Remark	Verdict
7.3.1	TABLE: External short circuit (cell)				P
Sample No.	Ambient (°C)	OCV at start of test (Vdc)	Resistance of circuit (mΩ)	Maximum case temperature rise ΔT (K)	Results
Samples charged at charging temperature upper limit (45°C)					
TS250704018C 06	55.2	4.19	80	65.1	A, B
TS250704018C 07	55.2	4.18	81	63.8	A, B
TS250704018C 08	55.2	4.18	83	64.2	A, B
TS250704018C 09	55.2	4.19	84	65.5	A, B
TS250704018C 10	55.2	4.18	82	64.7	A, B
Samples charged at charging temperature lower limit (0°C)					
TS250704018C 11	55.2	4.14	80	57.9	A, B
TS250704018C 12	55.2	4.15	79	58.1	A, B
TS250704018C 13	55.2	4.15	80	59.2	A, B
TS250704018C 14	55.2	4.15	81	58.4	A, B
TS250704018C 15	55.2	4.15	82	59.8	A, B
Supplementary information:					
A - No fire					
B - No explosion					

IEC 62133-2						
Clause	Requirement + Test				Result - Remark	Verdict
7.3.2	TABLE: External short circuit (battery)					P
Sample No.	Ambient T (°C)	OCV before test (Vdc)	Resistance of circuit (mΩ)	Maximum case temperature rise ΔT (K)	Component single fault condition	Results
TS25070401 8B04	23.1	4.19	82	80.2	Short circuit MOSFET U2	A, B
TS25070401 8B05	23.1	4.18	81	79.6	Short circuit MOSFET U2	A, B
TS25070401 8B06	23.1	4.19	80	78.3	Short circuit MOSFET U2	A, B
TS25070401 8B07	23.1	4.18	83	0.4	--	A, B
TS25070401 8B08	23.1	4.19	85	0.3	--	A, B
Supplementary information:						
A - No fire						
B - No explosion						

IEC 62133-2					
Clause	Requirement + Test			Result - Remark	Verdict
7.3.5	TABLE: Crush (cells)				P
Sample No.	OCV before test (Vdc)	OCV at removal of crushing force (Vdc)	Maximum force applied to the cell during crush (kN)	Results	
Samples charged at charging temperature upper limit (45°C)					
TS250704018C29	4.19	4.19	13.04	A, B	
TS250704018C30	4.18	4.18	13.03	A, B	
TS250704018C31	4.19	4.19	13.02	A, B	
TS250704018C32	4.18	4.18	13.04	A, B	
TS250704018C33	4.18	4.18	13.01	A, B	
Samples charged at charging temperature lower limit (0°C)					
TS250704018C34	4.15	4.15	13.04	A, B	
TS250704018C35	4.15	4.15	13.01	A, B	
TS250704018C36	4.15	4.15	13.03	A, B	
TS250704018C37	4.15	4.15	13.02	A, B	
TS250704018C38	4.15	4.15	13.01	A, B	
Note: A 13kN force applied at the wide side of prismatic cells. No voltage abrupt occurred.					
Supplementary information:					
A - No fire					
B - No explosion					

7.3.6	TABLE: Over-charging of battery				P
Constant charging current (A)			1.7	—	
Supply voltage (Vdc)			5.88	—	
Sample No.	OCV before charging (Vdc)	Total charging time (minute)	Maximum outer case temperature (°C)	Results	
TS250704018B12	3.36	90	38.6	A, B	
TS250704018B13	3.35	90	39.4	A, B	
TS250704018B14	3.35	90	38.1	A, B	
TS250704018B15	3.34	90	38.7	A, B	
TS250704018B16	3.37	90	38.8	A, B	
Supplementary information:					
A - No fire					
B - No explosion					

IEC 62133-2				
Clause	Requirement + Test	Result - Remark	Verdict	
7.3.7	TABLE: Forced discharge (cells)			P
Sample No.	OCV before application of reverse charge (Vdc)	Measured reverse charge I _r (A)	Lower limit discharge voltage (Vdc)	Results
TS250704018C3 9	3.31	0.85	3.0	A, B
TS250704018C4 0	3.31	0.85	3.0	A, B
TS250704018C4 1	3.32	0.85	3.0	A, B
TS250704018C4 2	3.32	0.85	3.0	A, B
TS250704018C4 3	3.31	0.85	3.0	A, B
Supplementary information: A - No fire B - No explosion				

7.3.8.1	TABLE: Vibration				P
Sample No.	OCV before test (Vdc)	OCV after test (Vdc)	Mass before test (g)	Mass after test (g)	Results
TS250704018B 17	4.19	4.19	15.207	15.205	A, B, C, D, E
TS250704018B 18	4.19	4.19	15.049	15.048	A, B, C, D, E
TS250704018B 19	4.19	4.19	15.136	15.136	A, B, C, D, E
Supplementary information: A - No fire B - No explosion C - No rupture D - No leakage E - No venting					

IEC 62133-2					
Clause	Requirement + Test			Result - Remark	Verdict
7.3.8.2	TABLE: Mechanical shock				P
Sample No.	OCV before test (Vdc)	OCV after test (Vdc)	Mass before test (g)	Mass after test (g)	Results
TS250704018B 20	4.18	4.18	15.165	15.163	A, B, C, D, E
TS250704018B 21	4.19	4.19	15.204	15.202	A, B, C, D, E
TS250704018B 22	4.18	4.18	15.067	15.065	A, B, C, D, E
Supplementary information:					
A - No fire					
B - No explosion					
C - No rupture					
D - No leakage					
E - No venting					

IEC 62133-2			
Clause	Requirement + Test	Result - Remark	Verdict

7.3.9	TABLE: Forced internal short circuit (cells)					P
Sample No.	Chamber ambient T (°C)	OCV before test (Vdc)	Particle location ¹⁾	Maximum applied pressure (N)	Results	
Samples charged at charging temperature upper limit (45°C)						
TS250704018C 44	45	4.18	1	400	A	
TS250704018C 45	45	4.19	1	400	A	
TS250704018C 46	45	4.18	1	400	A	
TS250704018C 47	45	4.19	1*	400	A	
TS250704018C 48	45	4.18	1*	400	A	
Samples charged at charging temperature lower limit (0°C)						
TS250704018C 49	0	4.14	1	400	A	
TS250704018C 50	0	4.15	1	400	A	
TS250704018C 51	0	4.15	1	400	A	
TS250704018C 52	0	4.15	1*	400	A	
TS250704018C 53	0	4.15	1*	400	A	
Supplementary information:						
¹⁾ Identify one of the following: 1: Nickel particle inserted between positive and negative (active material) coated area. 2: Nickel particle inserted between positive aluminium foil and negative active material coated area. Remark: *No position 2 exists. A - No fire						

D.2	TABLE: Internal AC resistance for coin cells				N/A
Sample no.	Ambient T (°C)	Store time (h)	Resistance Rac (Ω)	Results ¹⁾	
Supplementary information:					

IEC 62133-2			
Clause	Requirement + Test	Result - Remark	Verdict

TABLE: Critical components information					P
Object / part No.	Manufacturer/ trademark	Type / model	Technical data	Standard	Mark(s) of conformity ¹⁾
Cell	Shenzhen Nova Technology Limited	802050P	3.7V, 850mAh	IEC 62133-2:2017, IEC 62133-2:2017/AMD 1:2021	Tested with appliance
-Positive electrode	JIANGMEN KANHOO INDUSTRY CO., LTD	LCO-4	LiCoO ₂	--	--
-Negative electrode	SHANGHAI SHANSHAN TECHNOLOGY CO LTD	FSN-1	Graphite	--	--
-Electrolyte	Zhuhai Saiwei Electronic Materials Co., Ltd	SW-B004	LiPF ₆	--	--
-Separator	T&S Change your life	F16BMS	PE, Shutdown temperature: 135°C	--	--
PCB	Interchangeable	Interchangeable	V-0, 130°C	UL 796	UL approved
Protect IC (U1)	Shenzhen Developer Microelectronics Co., Ltd.	G3JP	V _{CU} : 4.25±0.025V, V _{DL} : 3.0±0.1V	--	Tested with appliance
MOSFET (U2)	Shenzhen Developer Microelectronics Co., Ltd.	8205A	V _{DS} : 20V, V _{GS} : ±12V, I _D : 5A	--	Tested with appliance
Lead wire	Interchangeable	Interchangeable	26AWG, 80°C, 30V	UL 758	UL approved
Tape	Interchangeable	Interchangeable	130°C	UL 510	UL approved
DC Connector	Interchangeable	Interchangeable	2 Pins	UL 1977	UL approved

Supplementary information:

¹⁾ Provided evidence ensures the agreed level of compliance. See OD-CB2039.

-- End of Report --

Product: Li-ion Polymer Battery

Type Designation: 802050P

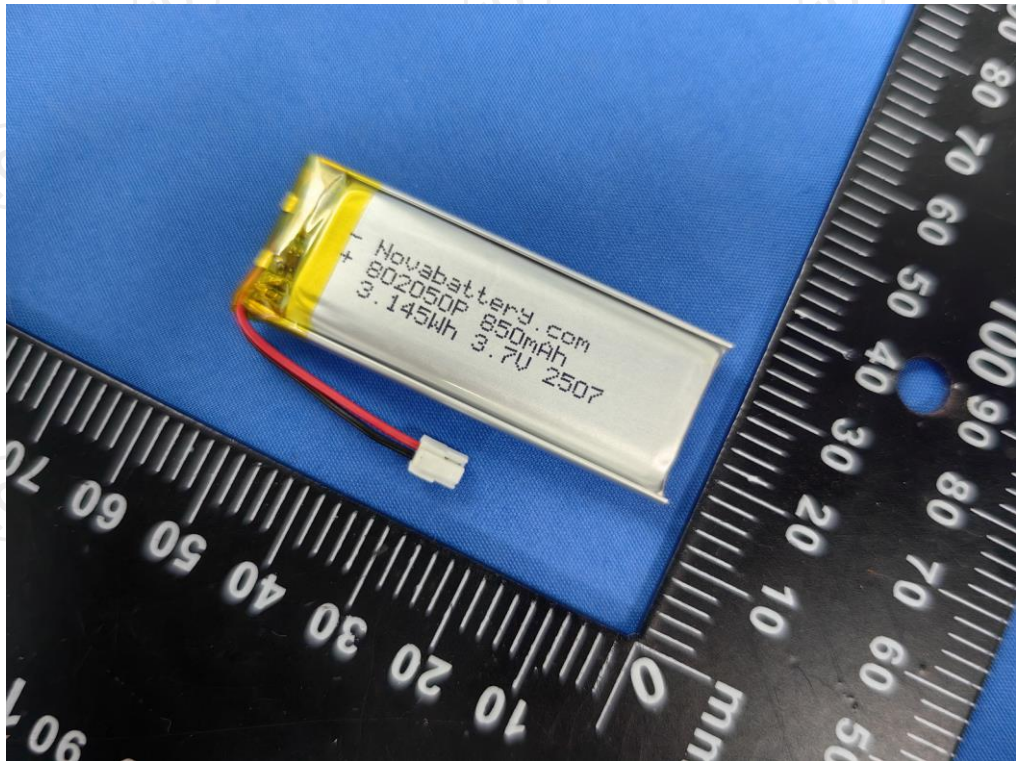

Picture 1. Front view of battery

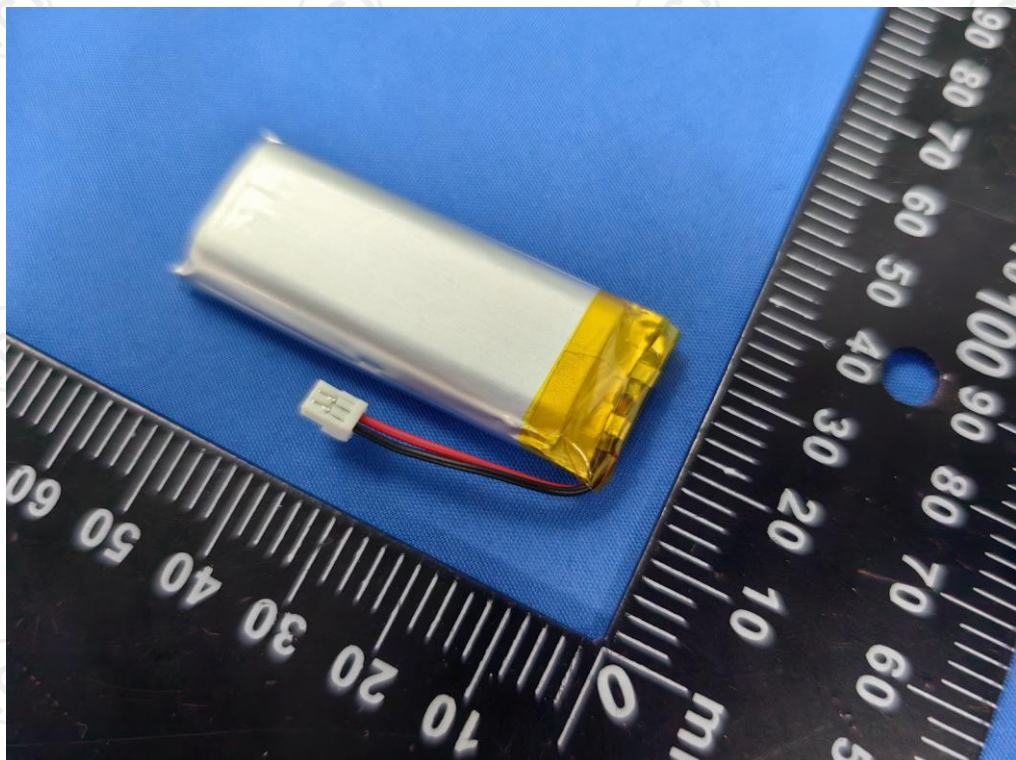

Picture 2. Back view of battery

Product: Li-ion Polymer Battery

Type Designation: 802050P

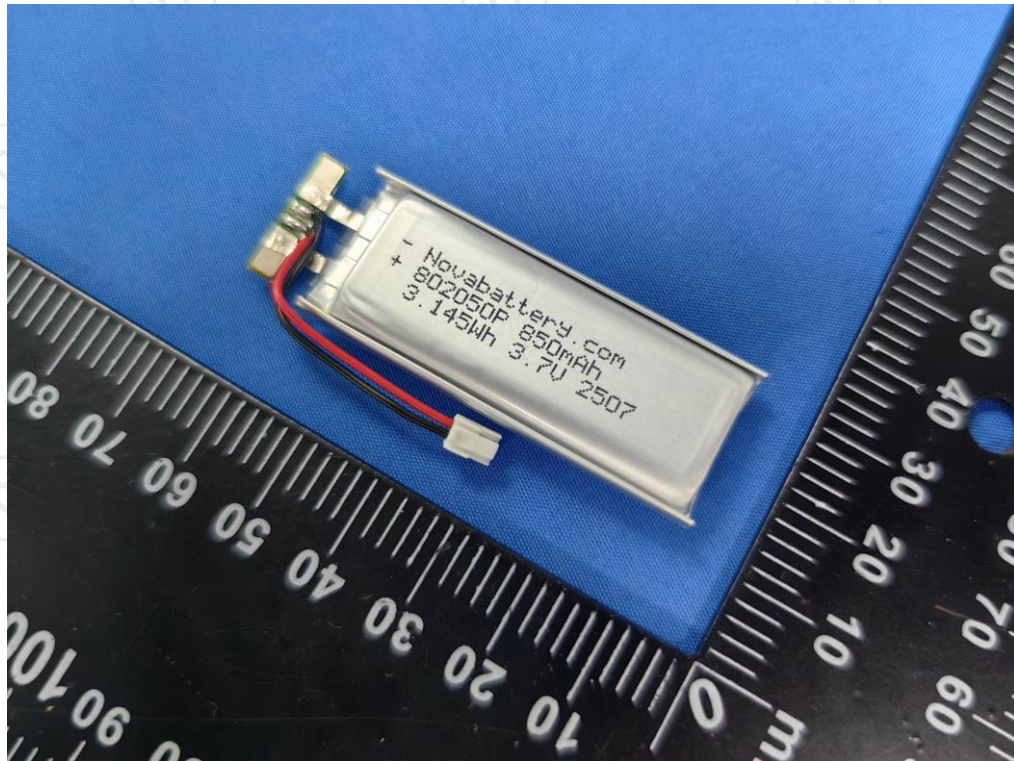

Picture 3. Inner view-1 of battery

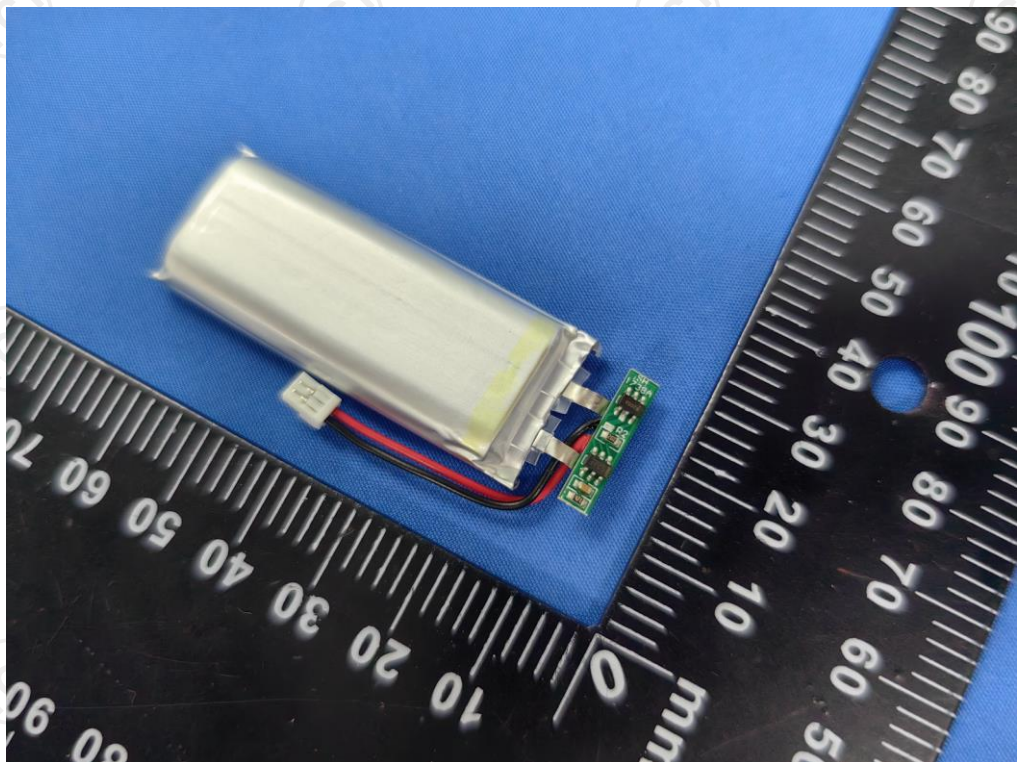

Picture 4. Inner view-2 of battery

Product: Li-ion Polymer Battery

Type Designation: 802050P

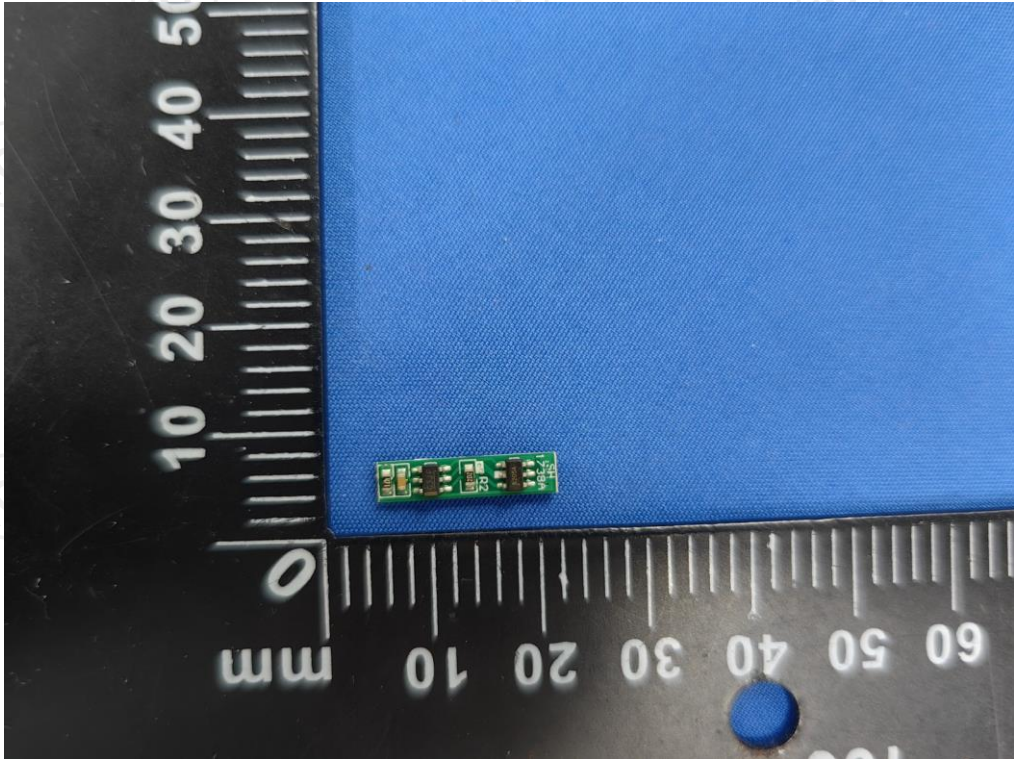

Picture 5. Front view-1 of protection board

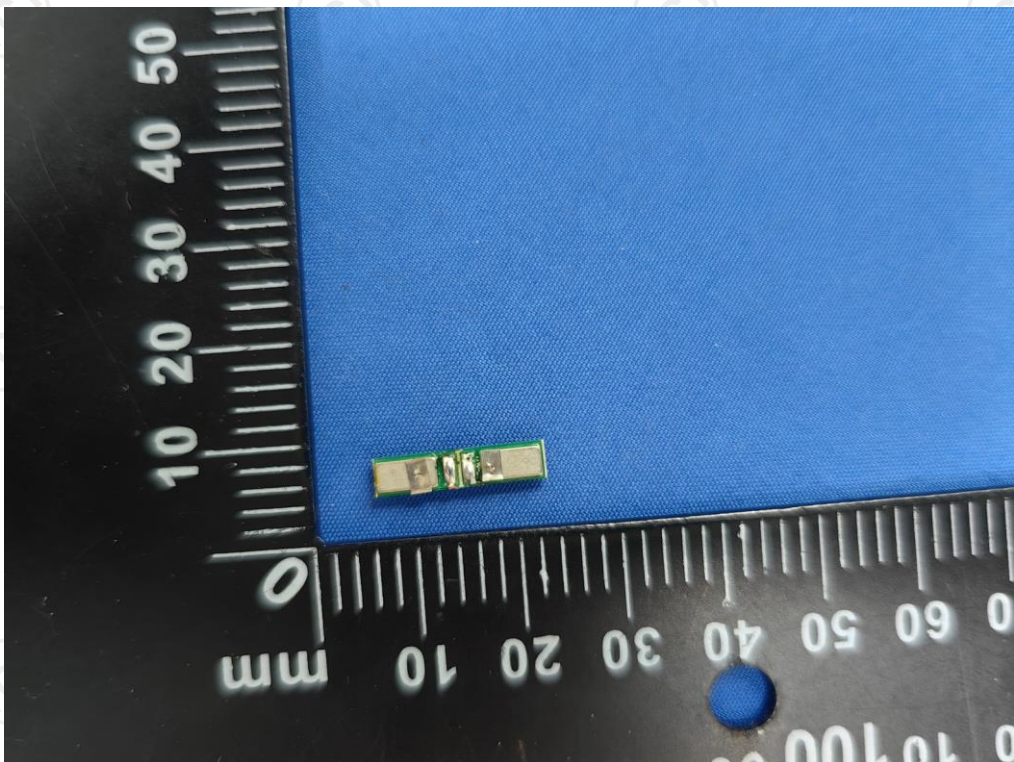

Picture 6. Back view-2 of protection board

Product: Li-ion Polymer Battery

Type Designation: 802050P

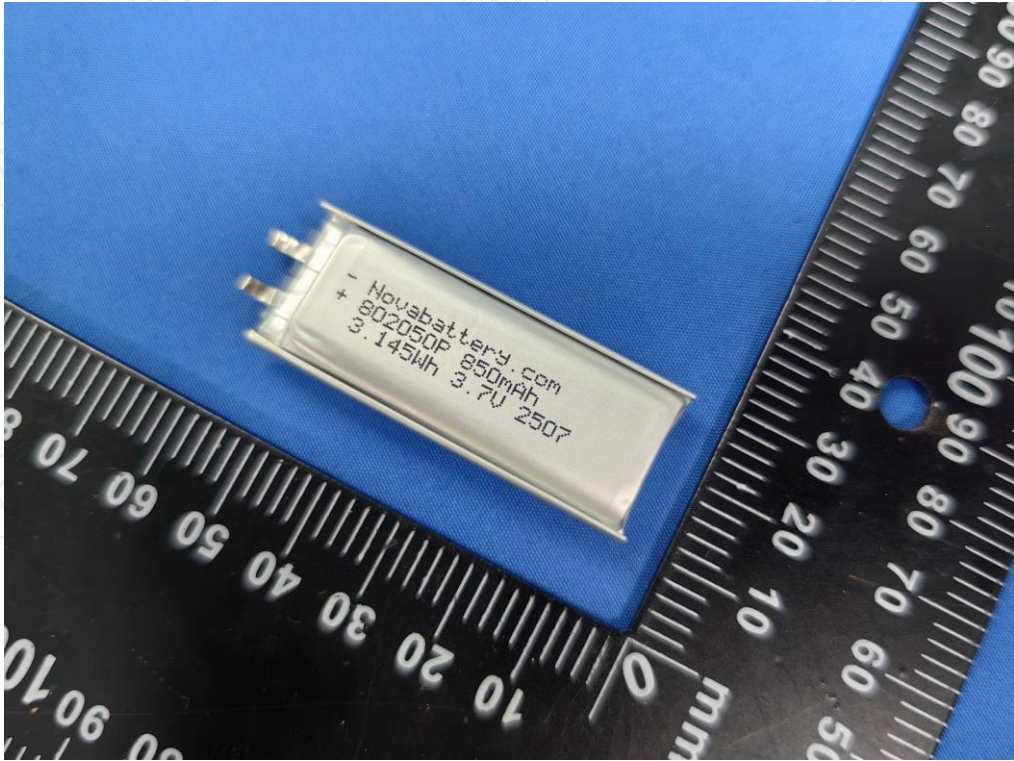

Picture 7. Front view of cell

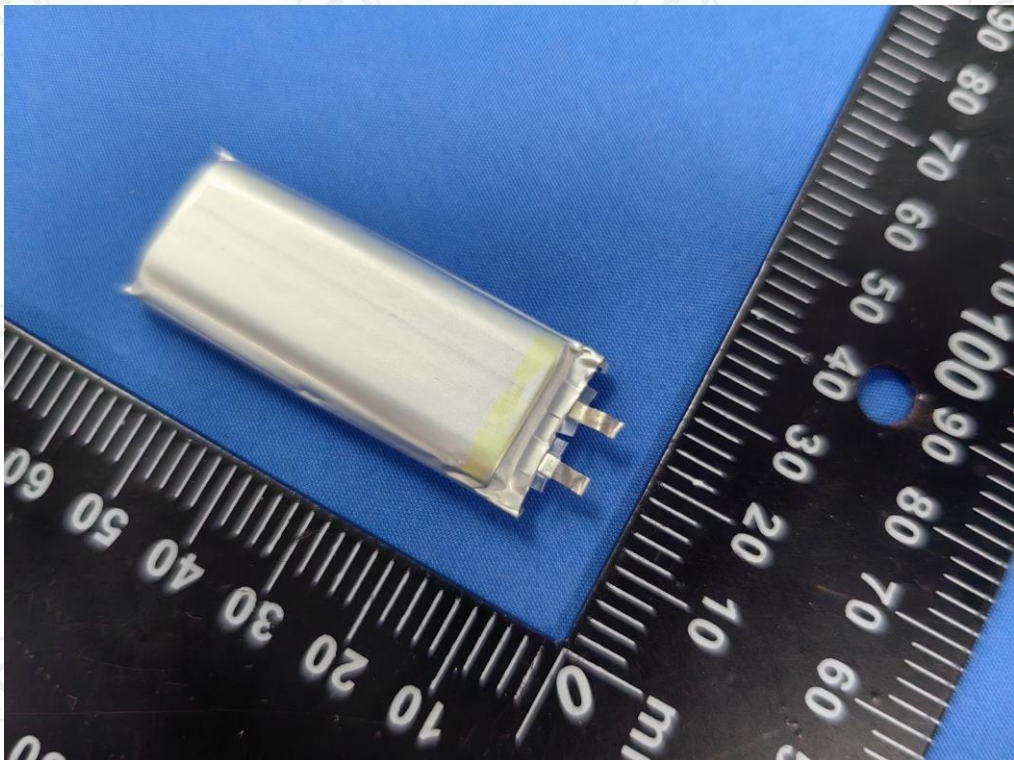

Picture 8. Back view of cell